



Electrolux
PROFESSIONAL

Stainless Steel Preparation 373x744 mm Aluminum Corner Unit

ITEM # _____

MODEL # _____

NAME # _____

SIS # _____

AIA # _____



137050 (ACS740)

Corner Shelving Set with aluminium side uprights and 4 polyethylene louvered shelves, 373x744 mm

Short Form Specification

Item No. _____

For corner installation. 4-level shelving set with louvered sectional polyethylene shelves (depth=373mm). Aluminium (20 micron) side uprights (height=1700mm). Adjustable feet. To be combined with a linear shelving unit

Main Features

- Complete shelving system allows rapid and easy fixing of the shelves to the uprights.
- GN 1/1, GN 1/2 and GN 1/3 can be inserted into the frame.

Construction

- Uprights and shelf frames constructed entirely in anodized aluminium (20 micron).
- Shelves made by section of polyethylene tablets.
- Sectional polyethylene shelves are dishwasher safe.
- Corner shelving must be fixed to a linear shelf (either 375mm or 475mm in depth) with the included bar clamps and can be positioned anywhere along the length of the linear shelf.
- 4 tiers and 4 corner clamps.

Optional Accessories

- Polyethylene shelf with aluminium frame, 373x708mm PNC 850035
- Angle joint for shelves (depth=373mm) PNC 850070
- 2 swivelling wheels, 100mm PNC 850072
- 2 swivelling wheels with brakes, 100mm PNC 850073

APPROVAL: _____



Experience the Excellence
www.electroluxprofessional.com

Front

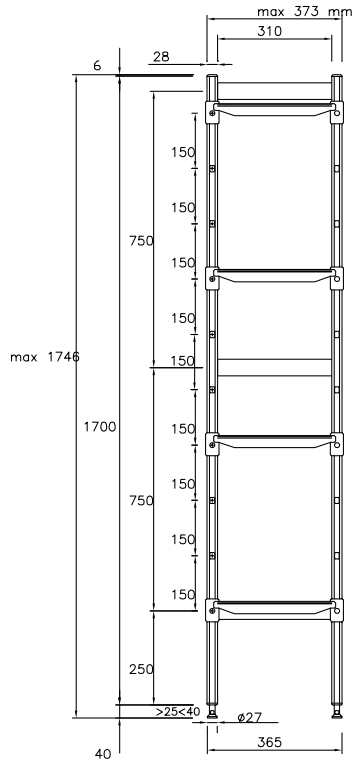

Top

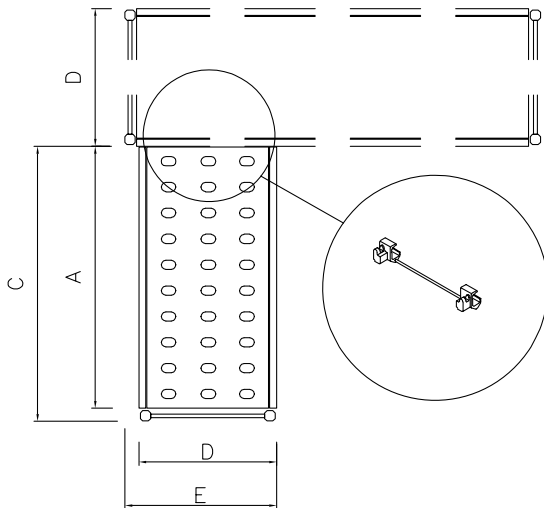

Other

	A mm	C mm	D mm	E mm
137050	708	744	373	407
137051	798	834	373	407
137052	886	922	373	407
137053	974	1010	373	407
137054	1062	1098	373	407
137055	1152	1188	373	407
137056	1240	1276	373	407
137057	1330	1366	373	407
137058	1505	1541	373	407

Key Information:
Uprights

137050 (ACS740) 1

External dimensions, Width: 744 mm

External dimensions, Depth: 373 mm

External dimensions, Height: 1700 mm

Max loading weight: 1040 kg

Net weight: 13 kg